

Adaptor JXCer-C-15

The adaptor is designed for **Jirous antennas** (of the required frequency band) and allows the installation of **Ceragon** and **Cambium** radio units. The adaptor allows fine adjustment of the polarization (attribute of OMT).

Technical parameters:

Frequency band	15 GHz
Polarization adjustment	yes - according OMT
Insert loss	< 0,1 dB
Waveguide	Circular
Material	Aluminum alloy with high corrosion protection Stainless steel
Weight	1 kg (2.2 lbs)
Package size/weight	220x235x50 mm / 1kg (2.2 lbs)

Compatible radio units:

Ceragon: all XPIC radio units (model name contains the letter **C**, e.g. IP-20C, IP-50C, ...)
Use the original Ceragon OMT.

Cambium: all XPIC radio units (model name contains the letter **C**, e.g. PTP-820C, PTP-850C, ...)
Use the original Cambium OMT.

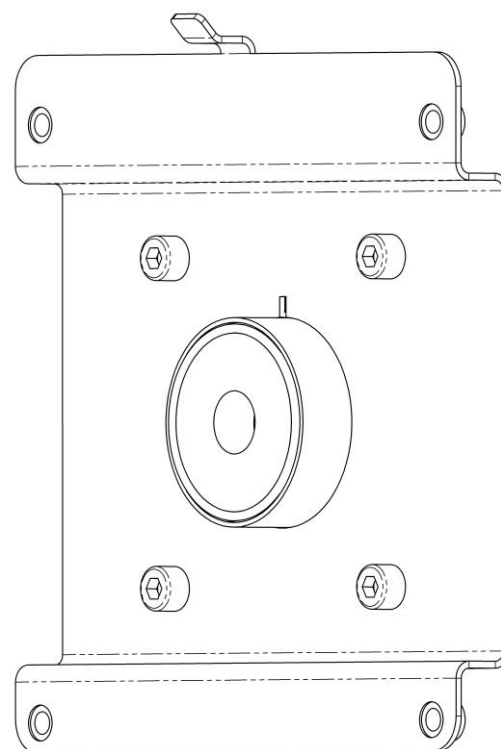

the adaptor

Adaptor JXCer-C-15

Suitable antennas:

Adaptors require mounting holes M8 at antenna (see pictures below). All Jirous antennas since the year 2022 are compatible.

400 mm / 1 ft antennas
with back part:

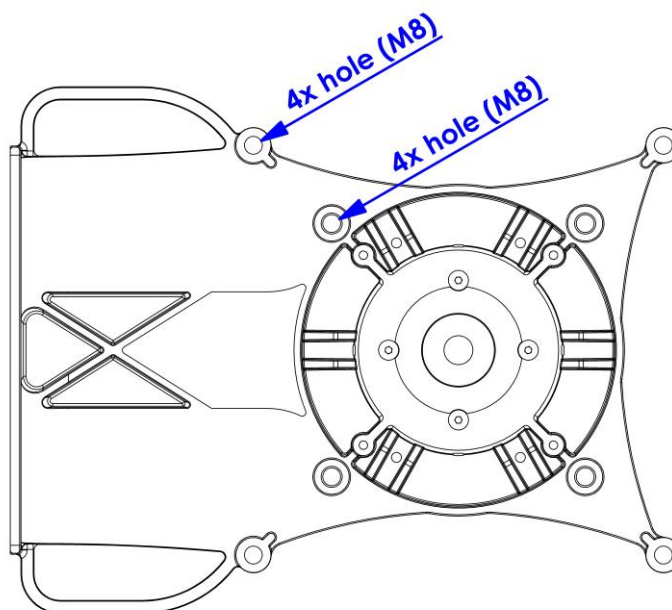

680 and 900 mm / 2 and 3 ft
antennas with back part:

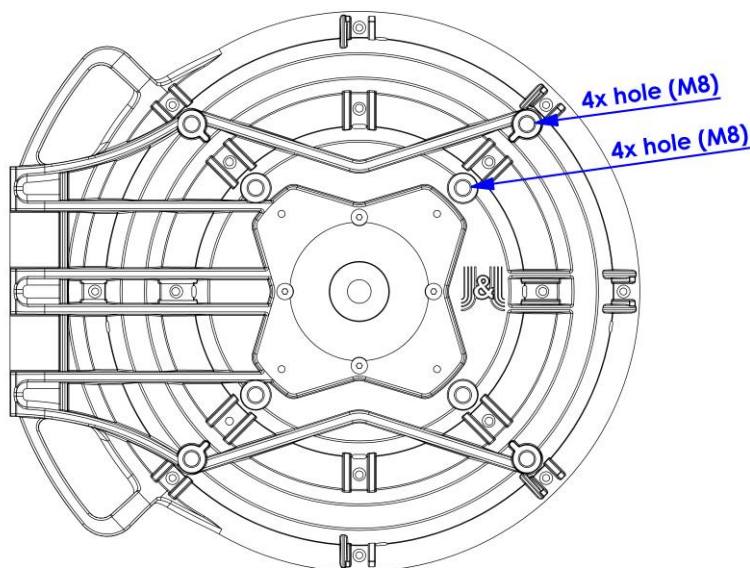

Adaptor JXCer-C-15

1200 mm / 4 ft antennas
with back part:

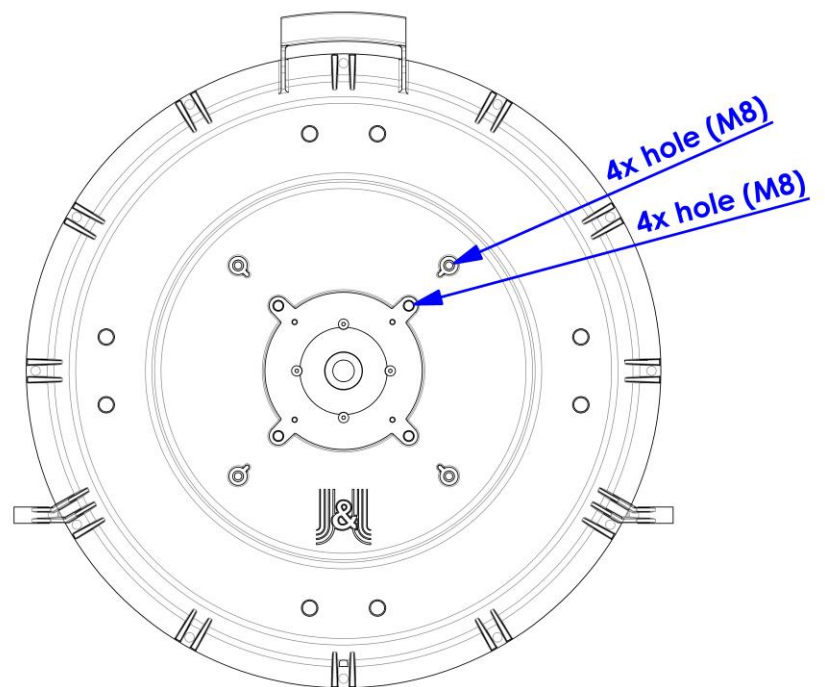

1800 mm / 6 ft antennas
with back part:

